



Bau- & Forsttechnik

Schwarzwald

Mulcherkatalog 25



Beratung / Verkauf / Wurde überreicht durch:

A large, empty white rectangular box intended for the user to write the name of the person who provided the consultation, sales, or delivery of the machine.

MULCHERKATALOG 25

Baggermulcher

3 - 4



Forstmulcher

5



Schlegelmulcher

6 - 11



Kreiselmulcher

12 - 13



Weidenmulcher

13



Heckenscheren

14 - 15

 Extra
erhältlich

2

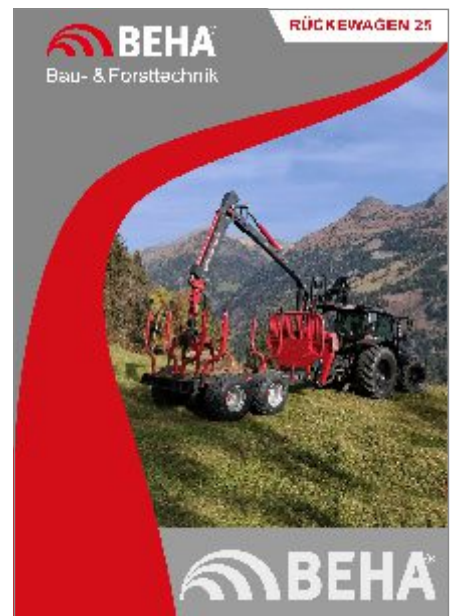

Baggermulchkopf TLBE

Der Hächselkopf TLBE ist ideal für die Zerkleinerung von Gras, Schilf und Strauchwerk mit einem Durchmesser von maximal 3 cm, in Gräben und Dammnähe und allen abschüssigen Geländen. Er kann auf Minibagger mit einem Gewicht von **1,5 - 7 Tonnen** Bagger eingesetzt werden.

Beschreibung Standardausführung

- Verbindungsplatte
- Hydraulikmotor Gruppe 2
- Vale Antikavitationseigenschaften
- Riemenantrieb
- Rotor mit glatten Hammerschlegeln
- Innengegenmesser
- Front Sicherheit durch verzinkte Ketten
- Hintere Sicherheit mit Gummi
- Seitliche Kufen
- Einstellbare hintere Walze mit Schaber



Lehnhoff Aufnahme













Parallelwippe



Hydraulikmotor



Modell											Art.- Nr.
	(g/min.)	L/1'	Press. BAR	Rotor mm	to						
TLBE 70	850	740	200	2000	30/45	250	108	7	2	2,5-4,5	134007050603
TLBE 90	1050	940	220	2000	30/45	250	108	9	2	3,5-6	134009050604
TLBE 120	1350	1240	270	2000	40/60	250	108	12	2	5,8	134012050882
Aufpreis											Art.- Nr.
Parallelwippe robust für TLBE 70-120											134000552142
Ersatz Löffelschlegel											139940051641

Baggermulchkopf TLBE-S

Der Häckselkopf TLBE-S ist ideal für die Zerkleinerung von Gras, Schilf und Strauchwerk mit einem Durchmesser von maximal 5 cm, in Gräben und Dammnähe und allen abschüssigen Geländen.

Er kann auf Bagger mit einem Gewicht von **5 - 10 Tonnen** Bagger eingesetzt werden.

Beschreibung Standardausführung

- Verbindungsplatte
- Hydraulikmotor Gruppe 3
- Anti Kavitationsventil
- Riemenantrieb
- Rotor mit gezackten Hammerschlegeln
- Innengegenrahmen
- Front Sicherheit mit verzinkten Ketten und Gummischutz
- Hintere Sicherheit durch Gummischutz und Ketten
- Seitliche Kufen
- Einstellbare hintere Walze mit Schaber



Front / Heckansicht













Parallelwippe

Hammerschlegel mit Zacken



4

Modell												Art.- Nr.
TLBE-S 100	1150	1040	310	2000	50/60	220-250	7	10	3	140	5-10	134510051593
TLBE-S 110	1250	1140	330	2000	60/70	220-250	8	11	3	140	5-10	134511052631
TLBE-S 120	1350	1240	350	2000	60/70	220-250	8	12	3	140	5-10	134512051594
Aufpreis												Art.- Nr.
Kolbenpumpe ab 80 Ltr. Öl (Leckleitung Pflicht)												134500051595
Parallelwippe robust für TLBE-S 100-120												134000551546
Ersatz Löffelschlegel												139940052241

FORST-Baggermulchkopf TLE-FL

Der hydraulische Forstmulchkopf TLE-FL ist ideal zum Zerkleinern von Gras, Hölzer und Sträucher bis zu 15 cm Durchmesser, an Gräben, Dämmen, unkultivierten Waldflächen und alle Arten von sehr steilem Gelände.

Er kann auf Bagger mit einem Gewicht von **12 - 18 Tonnen** eingesetzt werden.

Beschreibung Standardausführung

- Verbindungsplatte
- Hydraulikkolbenmotor
- Rotor mit glatten Hammerschlegeln
- Innengegenmesser aus verschleißfestem Stahl (Hardox)
- Vorderer und Hinterer Schutz mit verzinkten Ketten
- Seitliche Kufen mit verschleißfesten Stahlarmierungen
- Doppelwirkender Zylinder zum öffnen der Hydraulischen Klappe am Heck
- Stützfuß



Serienmäßig:



Hammerschlegel

optional:



Festgeschraubte Hämmer



Baggeraufnahme optional erhältlich (Lehnhoff / Martin)









Modell	1450	1110	Kg	(g/min.)	L/1'	Press. BAR	Rotor mm	18	5	Art.- Nr.
TLE-FL 120	1450	1110	740	2000	120/140	270	340	18	5	134612052632
TLE-FL 130	1630	1290	770	2000	120/140	270	340	21	5	134613052633
Festgeschraubte Hämmer TLE-FL120										134612053883
Festgeschraubte Hämmer TLE-FL130										134613053884

Schlegelmulcher









inkl. Gelenkwelle

Modell		 Drehzahl				 Schlegel Anzahl	Art.- Nr.
Master 125 M (Box)	1250	540	18-25	Cat.I	277	20	131012052601
Master 145 M (Box)	1450	540	25-35	Cat.I	317	24	131014052602
Master 155 M (Box)	1550	540	30-65	Cat.I	342	24	131015052603
Master 175 M (Box)	1750	540	35-65	Cat.I	392	28	131017052605
Ersatzschlegel 							139910053600

Schlegelmulcher

Serienmäßig
hydraulisch verschiebbar +/- 300 mm



Modell		 Drehzahl				 Schlegel Anzahl	Art.- Nr.
Master 155 (Box)	1550	540	30-65	Cat.I	367	20	131315052616
Master 175 (Box)	1750	540	35-65	Cat.I	412	24	131317052617
Master 200 (Box)	2000	540	50-70	Cat.I/II	460	24	131320052618
Master 220 (Box)	2200	540	75-90	Cat.I/II	500	28	131322053081
Ersatzschlegel 							139910053600

Schlegelmulcher

hydraulischer Antrieb für
Rad- /Hof- /Teelader



Radlader- /Hofladeraufnahmen
auf Wunsch möglich



inkl. Gelenkwelle

Modell			 Ltr.		 kg	 Schlegel Anzahl	Art.- Nr.
WLF 1300 (Box)	1300	33-50	40-45	W	320	22	131413053605
WLF 1700 (Box)	1700	33-50	40-45	W	353	28	131417053606
Ersatzschlegel 							139914053607
Aufpreis	Hoflader / Radlader						139914053608
Aufpreis	Euroaufnahme						139919053636





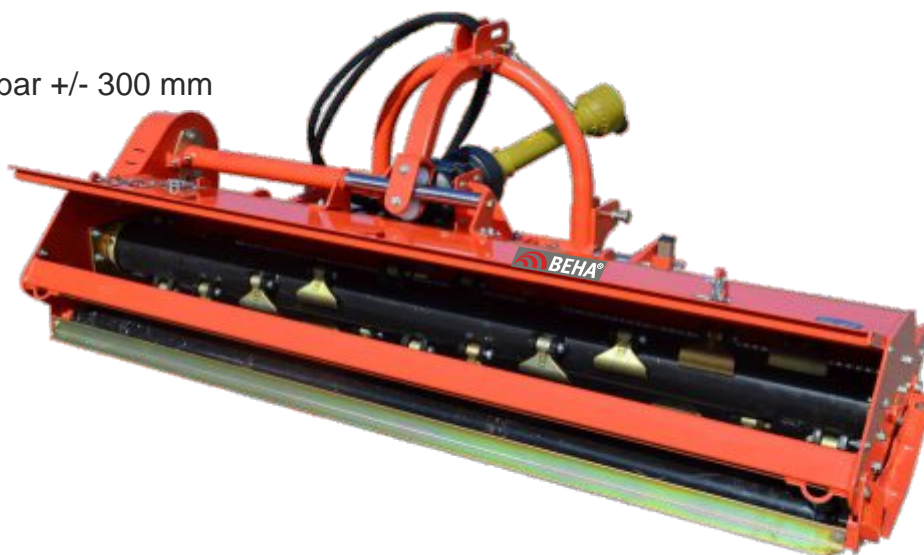



Schlegelmulcher

Serienmäßig
hydraulisch verschiebbar +/- 300 mm



Option
Hinter-Räder









Modell		 Drehzahl			 kg	 Schlegel Anzahl	Art.- Nr.
KDK 240 (Box)	2400	540	75-120	Cat.II	650	22	131524053609
KDK 300 (Box)	3000	540	100-150	Cat.II	1200	30	131530053610
Ersatzschlegel 							139921053604
Aufpreis 	Hinter-Räder						139915053611

Schlegelmulcher



Serienmäßig
hydraulisch verschiebbar +/- 400 mm

inkl. Gelenkwelle

Modell		 Drehzahl			 kg	 Schlegel Anzahl	Art.- Nr.
AG DUO 140 (Box)	1380	540	20-50	Cat.I/II	320	12	132114052619
AG DUO 170 (Box)	1680	540	30-50	Cat.I/II	370	16	132116052620
AG DUO 200 (Box)	1960	540	40-70	Cat.II	410	18	132120052621
AG DUO 220 (Box)	2180	540	55-80	Cat.II	460	20	132120052622
Ersatzschlegel 							139921053604

Schlegelmulcher









DUO



DUO plus









inkl. Gelenkwelle

Modell		 Drehzahl			 kg	 Schlegel Anzahl	Art.- Nr.
DUO 140	1380	540	20-50	Cat.I/II	320	12	133114053658
DUO 170	1680	540	30-50	Cat.I/II	370	16	133117053659
DUO 200	1960	540	40-70	Cat.II	410	18	133120053660
DUO 220	2180	540	55-80	Cat.II	460	20	133122053661
Ersatzschlegel 							139921053604
Modell							Art.- Nr.
DUO 250 plus	2500	1000	85-150	Cat.II/III	960	22	133225053662
DUO 280 plus	2800	1000	100-150	Cat.II/III	1064	26	133228053663
DUO 300 plus	3000	1000	100-150	Cat.II/III	1230	30	133230053664
Ersatzschlegel 							139932053665

Schlegelmulcher



inkl. Gelenkwelle

Modell		 Drehzahl				 Schlegel Anzahl	Art.- Nr.
AGL 110 MINI (Box)	1100	540	15-35	Cat.I	230	18	132411053612
AGL 130 MINI (Box)	1300	540	18-50	Cat.I	260	22	132413053613
Ersatzschlegel 							139924053614

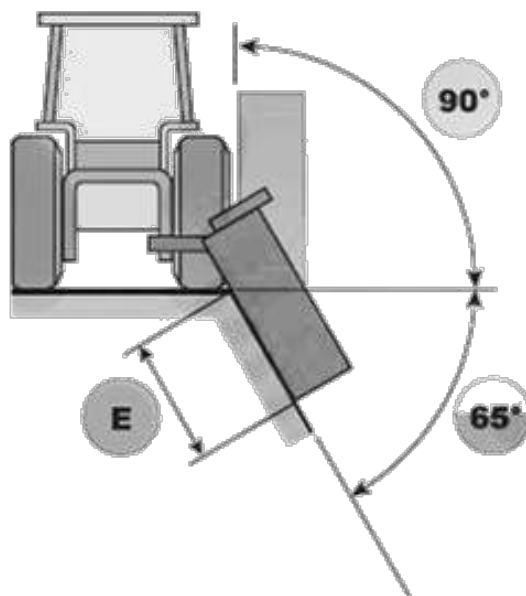
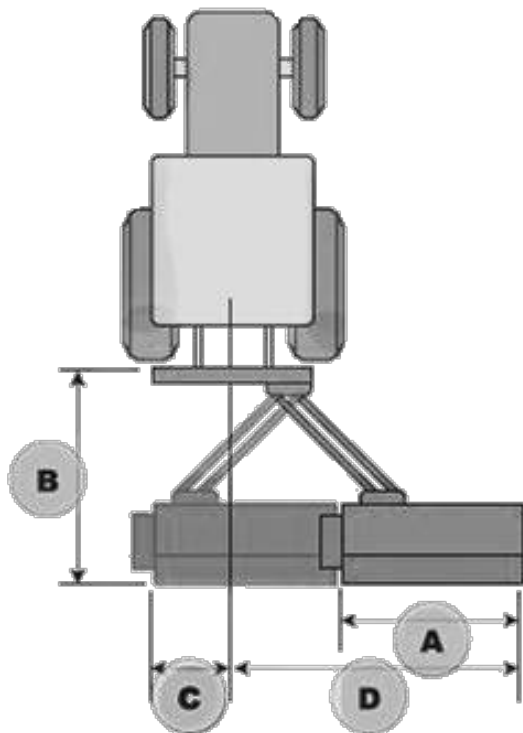







Modell	A	B	C	D	E
AGL 110 MINI (Box)	1100	1200	400	1830	850
AGL 130 MINI (Box)	1300	1200	400	2030	1050

Schlegelmulcher



inkl. Gelenkwelle

Modell		 Drehzahl				 Schlegel Anzahl	Art.- Nr.
AGL 125 (Box)	1250	540	20-60	Cat.I	250	20	132212052623
AGL 145 (Box)	1450	540	25-60	Cat.I	270	24	132214052624
AGL 165 (Box)	1650	540	30-70	Cat.I	290	28	132216052625
AGL 185 (Box)	1850	540	40-75	Cat.I/II	342	30	132218053601
AGL 200 (Box)	2000	540	45-80	Cat.I/II	355	32	132220053602

Ersatzschlegel



139922053603

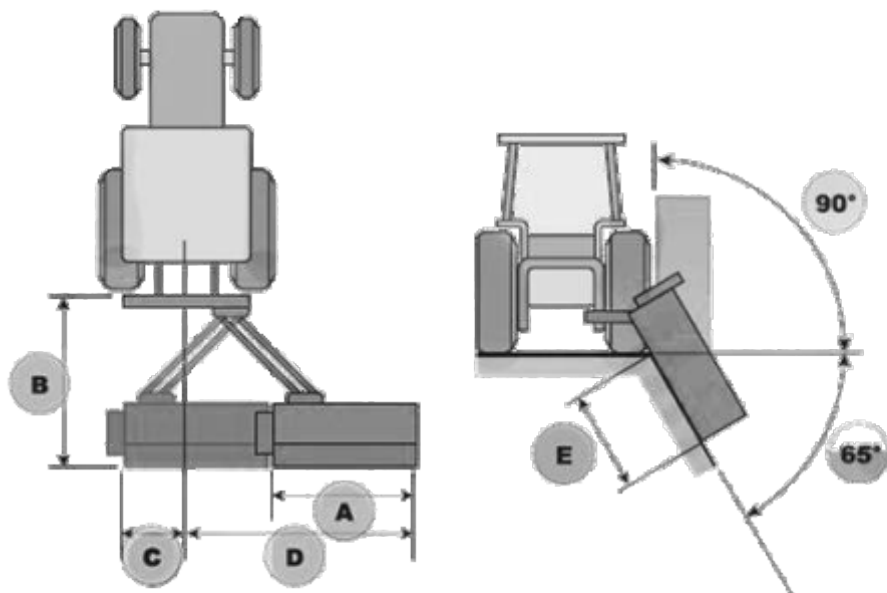

Modell	A	B	C	D	E
AGL 125 (Box)	1200	1300	760	1800	1050
AGL 145 (Box)	1400	1300	760	2000	1250
AGL 165 (Box)	1600	1300	760	2200	1450
AGL 185 (Box)	1850	1300	660	2350	1650
AGL 200 (Box)	2000	1300	660	2500	1800

Schlegelmulcher





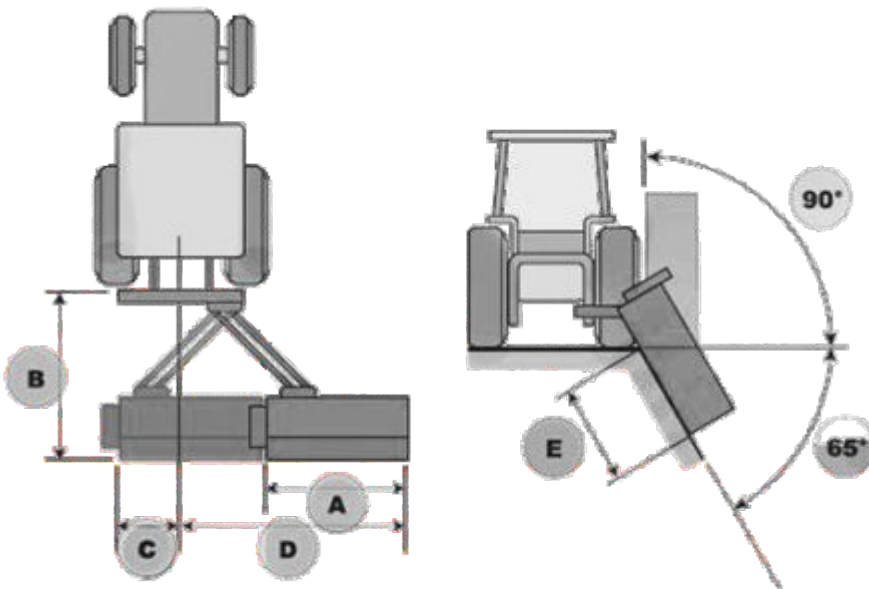





inkl. Gelenkwelle Modell		Drehzahl 				Schlegel Anzahl	Art.- Nr.
AGF 140 (Box)	1400	540	50-80	Cat.II	520	14	132314052626
AGF 160 (Box)	1600	540	60-95	Cat.II	560	16	132316052627
AGF 180 (Box)	1800	540	70-110	Cat.II	600	18	132318052628
AGF 200 (Box)	2000	540	80-110	Cat.II	650	20	132320052629
AGF 220 (Box)	2200	540	90-120	Cat.II	685	20	132322053069
AGF 240 (Box)	2400	540	90-120	Cat.II	720	24	132324053099
Ersatzschlegel							139921053604



Modell	A	B	C	D	E
AGF 140 (Box)	1400	1630	240	2340	1200
AGF 160 (Box)	1600	1630	240	2540	1400
AGF 180 (Box)	1800	1630	240	2740	1600
AGF 200 (Box)	2000	1650	240	2920	1800
AGF 220 (Box)	2200	1650	240	3120	2000
AGF 240 (Box)	2400	1650	240	3120	2200







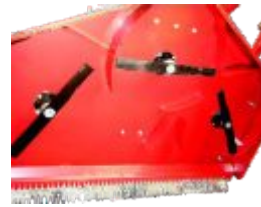

Kreiselmulcher



Modell		 Drehzahl			 kg	 Messer Anzahl	Art.- Nr.	Ersatzmesser Art.- Nr.
FAG 1200 (Box)	1200	540	14 - 40	Cat.I	195	3	131712053621	 139916053618
FAG 1500 (Box)	1500	540	14 - 40	Cat.I	220	3	131715053622	 139916053619
FAG 1800 (Box)	1800	540	14 - 50	Cat.I	250	3	131718053623	 139916053620

Kreiselmulcher











Modell		 Drehzahl			 kg	 Messer Anzahl	Art.- Nr.	Ersatzmesser Art.- Nr.
FA 1500XL (Box)	1500	540	18 - 50	Cat.I	200	3	131815053624	 139918053627
FA 1800XL (Box)	1800	540	22 - 50	Cat.I	235	3	131818053625	 139918053628
FA 2100XL (Box)	2100	540	22 - 60	Cat.I	330	3	131821053626	 139918053629

Kreiselmulcher für Radlader

Radlader- /Hofladeraufnahmen auf Wunsch möglich



Modell					 kg	 Messer Anzahl	Art.- Nr.	Ersatzmesser Art.- Nr.
LM 1200 (Box)	1200	29 - 32	18 - 50	W	235	3	131912053621	 139919053633
LM 1500 (Box)	1500	29 - 32	22 - 50	W	250	3	131915053622	 139919053634
LM 1800 (Box)	1800	45	22 - 50	W	275	3	131918053623	 139919053635
Aufpreis	Euro Aufnahme						139919053636	







Kreiselmulcher



Modell		 Drehzahl			 kg	 Messer Anzahl	Art.- Nr.
FMU 150 (Box)	1500	540	18 - 50	Cat.I	200	6	132015053637
FMU 180 (Box)	1800	540	22 - 50	Cat.I	235	6	132018053638







Kreiselmulcher



Modell		 Drehzahl				 Messer Anzahl	Art.- Nr.
FMU 150D (Box)	1500	540	18 - 50	Cat.I	200	8	132515053639
FMU 180D (Box)	1800	540	22 - 50	Cat.I	235	8	132518053640







Weidmulcher



Modell		 Drehzahl				 Messer Anzahl	Art.- Nr.	 Ersatzmesser Art.- Nr.
BLG 120 (Box)	1200	540	14 - 40	Cat.I	210	2	132712053642	139927053645
BLG 160 (Box)	1600	540	25 - 60	Cat.I	316	2	132716053643	139927053645
BLG 200 (Box)	2000	540	40 - 80	Cat.I	458	2	132720053644	139927053645







Weidmulcher



Modell		 Drehzahl				 Messer Anzahl	Art.- Nr.	 Ersatzmesser Art.- Nr.
WB 185 (Box)	1850	540	30 - 70	Cat.II	240	4	132818553646	139928053648
WB 275 (Box)	2750	540	50 - 80	Cat.II	485	6	132827553647	

Weidmulcher







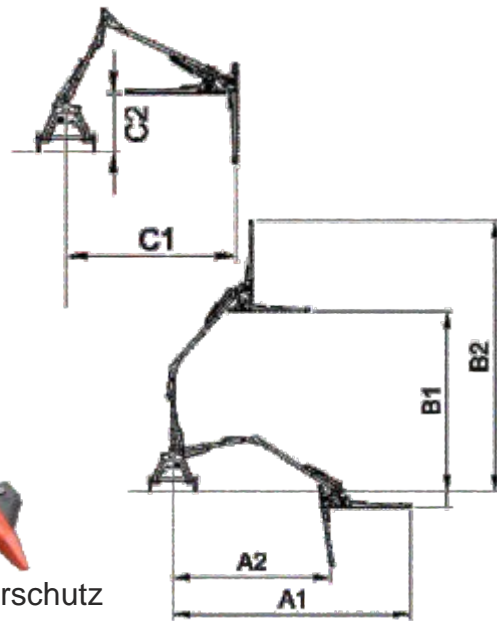

Modell		 Drehzahl				 Messer Anzahl	Art.- Nr.	 Ersatzmesser Art.- Nr.
WB 240 XL (Box)	2400	540	60 - 90	Cat.II	462	4	132924053649	139929053651
WB 300 XXL (Box)	3000	540	70 - 1200	Cat.II	723	4	132930053650	139929053652

Heckenschere



Messerschutz







Modell		 Drehzahl					Art.- Nr.
HSC 160XL	1600	540	25 - 40	Cat.I	330	20	133316053666
Messer (komplett) Typ 160							139935053674
Maß	A1	A2	B1	B2	C1	C2	
Angabe in mm	4800	3200	3700	5500	2800	1000	

Front-Heckenschere

 Radlader- /Hofladeraufnahmen
auf Wunsch möglich

Messerschutz

Arbeitsgeschwindigkeit: max. 2-4 km/h

Modell							Art.- Nr.
FHSC 160 Euro	1600	3	80	300	140-180	20	133416053667
FHSC 160 W	1600	3	80	300	140-180	20	133416153668
Messer (komplett) Typ 160							139935053674

Heckenschere





Ersatzmesser für

Modell	Art.- Nr.
TYP 130	139935053673
TYP 160	139935053674
TYP 175	139935053675
TYP 190	139935053676
Messerschutz	139935053677







Messerschutz

Modell		 kg		max. Ast	Art.- Nr.
HS 130	1300	36	25	10-20	133513053669
HS 160	1600	43	25	10-20	133516053670
HS 175	1750	46	25	10-20	133517553671
HS 190	1900	51	25	10-20	133519053672

Heckenschere



Modell		 kg		max. Öldruck		Blatt	max. Ast	Art.- Nr.
CUT 3	900	53	40	180	3	400	80	133609353678
CUT 5	1500	77	70	180	5	400	80	133615553679

Hohe **QUALITÄT.** Guter **SERVICE.** Einfach **BEHA.**

- Rückewagen & Kräne
- Ruckekräne
- Seilwinden
- Frontladergreifer
- Rückezange
- Entastungsgeräte
- Holzspalter
- Kreissägen
- Bündelgeräte
- Polterschilder
- Kegelspalter
- Allzweckschaufeln
- Pendelgelenke
- Greifer
- Universalgreifer
- Palettengabeln
- Rotatoren
- Zubehör

